

50A SPACE SAVING RCBO 10kA 1P+N SINGLE MODULE B CURVE 230V A

- Single module space saving RCBO
- Breaking capacity 10 kA
- 50A B-Curve
- 30mA, Type A
- Reduced height 99.5 mm



General information

Standards	BS EN IEC 61009-1 BS EN IEC 61009-2-2
Width in number of modular spacing	1
Design of pole	1P+N
Number of protected poles	1
Neutral can be switched	No
Position of neutral terminal	Right
Trip unit technology	Thermal-magnetic
Tripping characteristic	Type B
Rated current I_n [A]	50
Residual current-detection principle	Electronic (voltage dependent)
Type of residual current	Type A
Residual current protection time delay	General type without time delay
Rated residual operating current ($I_{\Delta n}$) [mA]	30
Breaking capacity	
Rated ultimate short-circuit breaking capacity (I_{cn}) [kA]	10
Rated residual breaking and making capacity ($I_{\Delta m}$) [kA]	2
Energy limiting class	3
Barcode (EAN-13)	5060690138501

Technical information

Nature of power supply	AC
Rated operational voltage (U_e) [V]	240 (230)
Rated frequency (f) [Hz]	50/60
Rated insulation voltage (U_i) [V]	500
Rated impulse withstand voltage (U_{imp}) [kV]	4
Contact position indication	Green/Red windows
Endurance	
• Mechanical [ops.]	20000

Danson Electrical UK Limited.

● Electrical	[ops.]	10000
--------------	----------	-------

Environmental information

Degree of protection		
● Housing		IP40
● Terminals		IP20
Pollution degree		
		3
Overvoltage category		
		III
Altitude (maximum)		
	[Meter]	Max. 2000
Ambient air temperature for operation		
● Minimum	[°C]	-25
● Maximum	[°C]	+45
Ambient air temperature for storage		
● Minimum	[°C]	-40
● Maximum	[°C]	+70
Reference ambient air temperature		
		[°C] 30
Relative humidity		
		28 cycles with +20 °C/95% and +40 °C/50%

Package information

Package level 1		
Type		
		Box
Number of units in package level 1		
	[pcs]	1
Weight		
	[g]	174
Length		
	[cm]	13
Width		
	[cm]	24
Height		
	[cm]	8
Package level 2		
Type		
		Carton
Number of units in package level 2		
	[pcs]	108
Weight		
	[kg]	17.8
Length		
	[cm]	45
Width		
	[cm]	24
Height		
	[cm]	34
Package level 3		
Type		
		Pallet
Number of units in package level 3		
	[pcs]	3240
Weight		
	[kg]	549
Length		
	[cm]	120
Width		
	[cm]	100
Height		
	[cm]	125

Mounting & Connection

Mounting position		
		Any
Mounting method		
		on DIN rail EN 60715 (35 mm) by means of clip

Danson Electrical UK Limited.

Power supply connection	Bottom terminal
Terminal type	
Bottom	
<ul style="list-style-type: none"> Line live terminal 	Screw terminals
Top	
<ul style="list-style-type: none"> Load live terminal Load neutral terminal Line neutral terminal 	Screw terminals Screw terminals Flying neutral lead
<ul style="list-style-type: none"> - Section [mm²] - Length [mm] - Colour 	4 600 Blue
Function earth cable	No
Colour of function earth cable	-
Recommended screw driver	Pozidriv 2
Connection capacity	
Line live terminal	
<ul style="list-style-type: none"> Flexible/Stranded 	
<ul style="list-style-type: none"> - Minimum [mm²] - Maximum [mm²] 	1 25
<ul style="list-style-type: none"> Solid 	
<ul style="list-style-type: none"> - Minimum [mm²] - Maximum [mm²] 	1 35
Load live & neutral terminals	
<ul style="list-style-type: none"> Flexible/Stranded/Solid 	
<ul style="list-style-type: none"> - Minimum [mm²] - Maximum [mm²] 	1 10
Wiring stripping length	[mm] 11.5
Tightening torque	
<ul style="list-style-type: none"> Line live terminal [N.m] Load live & neutral terminals [N.m] 	2 2.5
Sealable handle	Yes

Diagram

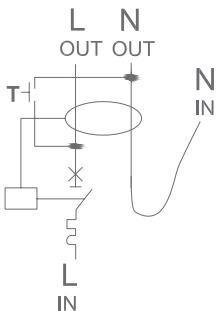

E-DLZS2150

Dimensions

Height [mm]	Width [mm]	Depth [mm]	Weight [g]
99.5	17.8	76.2	151

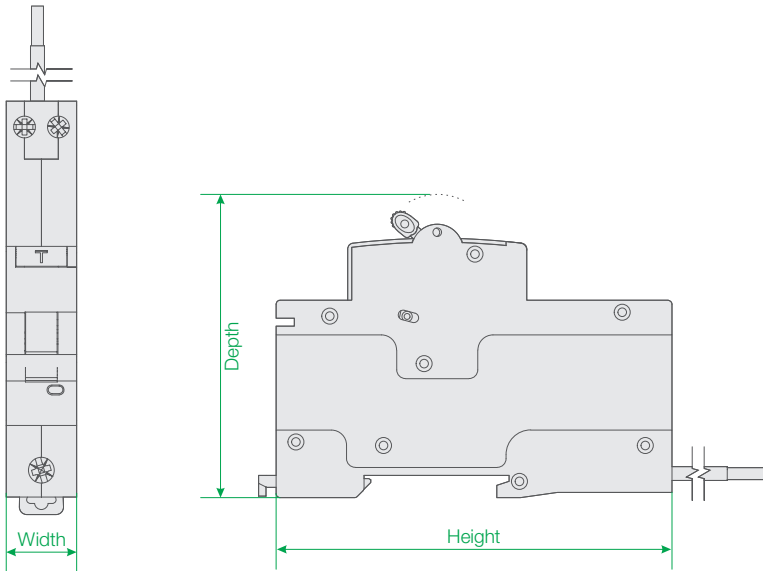

Certificate

**UK
CA**

CE

CB